

Vector Network Measurement Systems

MS462x A/B/C/D
10 MHz to 9 GHz

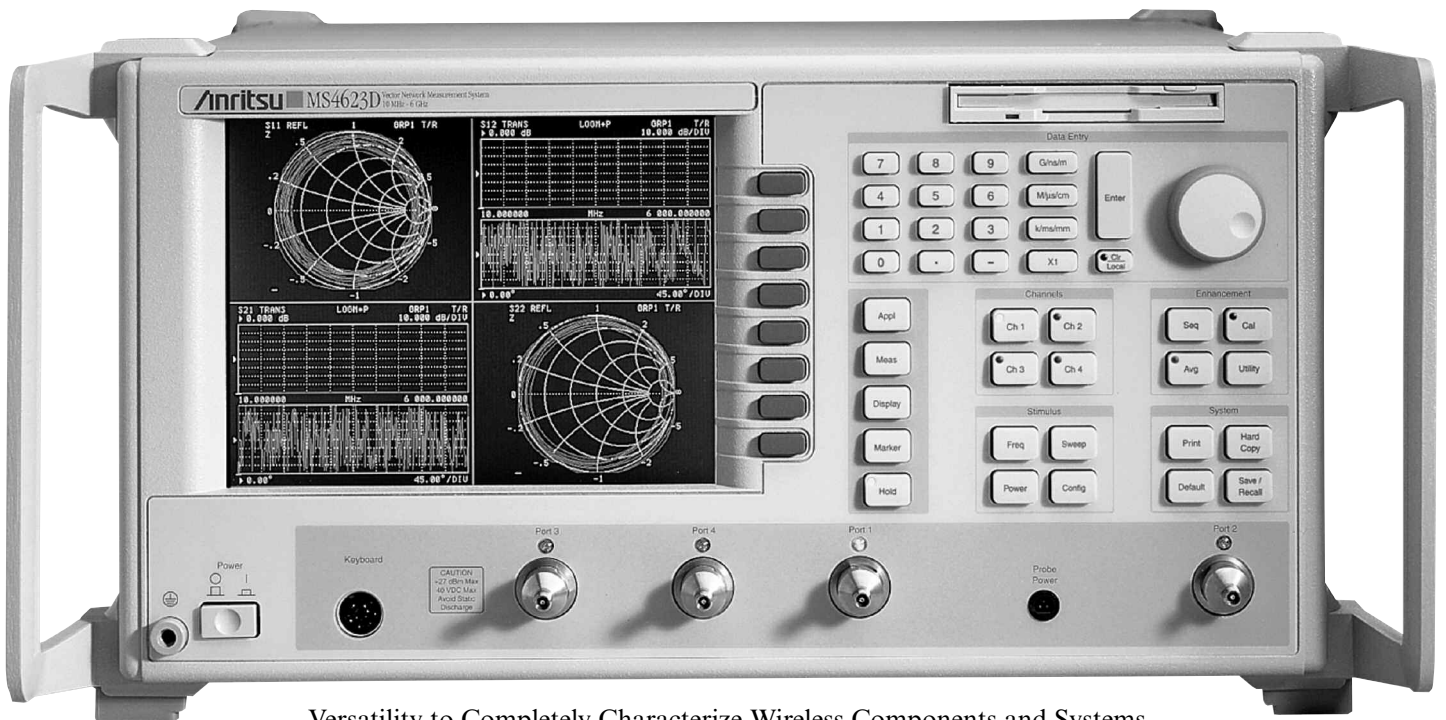

Versatility to Completely Characterize Wireless Components and Systems

MS462xx Typical Specifications Overview

	MS4622x	MS4623x	MS4624x
Frequency Range	10 MHz to 3 GHz	10 MHz to 6 GHz	10 MHz to 9 GHz
MS462xA T/R ¹ MS462xB S-Parameter MS462xC DRA ² MS462xD 4-Port	✓ ✓ ✓ ✓	✓ ✓ ✓ ✓	✓ ✓ ✓ ✓
Source Summary Power Range (No Options) Level Accuracy Sweep Range Harmonics Stability	+10 to -85 dBm ±1 dB 20 dB Minimum -30 dBc <5 ppm / year	+7 to -85 dBm ±1 dB 20 dB Minimum -30 dBc <5 ppm / year	+7 to -85 dBm ±1.5 dB4 20 dB Minimum -25 dBc <5 ppm / year
Receiver Summary Average Noise, 10 Hz <3 GHz ⁵ 3 to 6 GHz 6 to 9 GHz 0.1 dB Compression Maximum Input Damage Level	-115 dBm +7 dBm +27 dBm +30 dBm	-115 dBm -105 dBm +7 dBm +27 dBm +30 dBm	-115 dBm -115 dBm -105 dBm +7 dBm +27 dBm +30 dBm
System Dynamic Range (Terminated) 10 to 3000 MHz 3000 to 6000 MHz 6000 to 9000 MHz	125 dB	125 dB 110 dB	125 dB 120 dB 110 dB
High Level Noise 10 to 3000 MHz 3000 to 6000 MHz 6000 to 9000 MHz	<0.008 dB rms	<0.008 dB rms <0.018 dB rms	<0.008 dB rms <0.018 dB rms <0.018 dB rms
Standard Features Mixed-Mode S-Parameters Embedding/De-embedding Arbitrary Impedance Power Sweep/Gain Compression Mixer Measurements Pass/Fail, Limit Lines 12 Independent Markers AutoCal [®] Calibration Multiple Source Control	✓ ✓ ✓ ✓ ✓ ✓ ✓ ✓ ✓	✓ ✓ ✓ ✓ ✓ ✓ ✓ ✓ ✓	✓ ✓ ✓ ✓ ✓ ✓ ✓ ✓ ✓
Optional Features Time Domain Noise Figure ³ Intermodulation Distortion Harmonics Mixer Group Delay	✓ ✓ ✓ ✓ ✓	✓ ✓ ✓ ✓ ✓	✓ ✓ ✓ ✓ ✓
Measurement Speed	150 µsec/point	150 µsec/point	150 µsec/point

¹T/R is economical Transmission/Reflection (or one-path, two-port) configuration that measures S₁₁, S₂₁

²DRA is Direct Receiver Access configuration for use in developing custom solutions.

³Noise Figure measurements start at 50 MHz. Options available for 3 for 6 GHz.

⁴Level Accuracy ±1 dB to 6 GHz, ±1.5 dB to 9 GHz.

⁵Some degradation below 50 MHz.

Other Notes

IF Bandwidth Range: 10 Hz, 30 Hz, 100 Hz, 300 Hz, 1 kHz, 3 kHz, 10 kHz, and 30 kHz

Data Points: 1, 3, 15, 51, 101, 201, 401, 801, and 1601; Arbitrarily use Discrete Fill for 2 to 1601 points

Impedance: 50 Ohms; Frequency Resolution: 1 Hz

Standard Connector Type: N-female; Optionally 3.5 mm female, 3.5 mm male, GPC-7, and N-male

Dimensions: 224H x 425W x 450D mm (8.75 x 16.75 x 17.75 in.)

Weight: Ranges between 16 kg (35 lb.) and 23 kg (52 lb.) depending upon model and options

Power Requirements: 85-240V, 48-63Hz, 540 VA maximum

System Description

The foundation of the Scorpion® MS462xx Vector Network Measurement System (VNMS) is a high performance 2-port S-parameter measurement engine consisting of a single flexible source and ultra-linear receiver. This vector network analyzer (VNA) engine provides all the necessary features to thoroughly characterize your RF components versus time, frequency and power. Simply upgrade your Scorpion, as shown in the following table, to further apply this powerful engine towards performing 3 and 4-Port S-parameter measurements...

S-Parameter Model Configuration Overview

Configuration	10 MHz - 3 GHz	10 MHz - 6 GHz	10 MHz - 9 GHz
2-Port T/R ¹	MS4622A	MS4623A	MS4624A
2-Port	MS4622B	MS4623B	MS4624B
3-Port	MS4622B + MS4600/3A	MS4623B + MS4600/3B	MS4624B + MS4600/3E
3-Port T/R ²	MS4622B + MS4600/6	MS4623B + MS4600/6	MS4624B + MS4600/6
4-Port	MS4622D	MS4623D	MS4624D
2-Port DRA ³	MS4622C	MS4623C	MS4624C
3-Port DRA ³	MS4622C + MS4600/3C	7MS4623C + MS4600/3D	MS4624C + MS4600/3F

¹T/R is economical Transmission/Reflection (or one-path, two-port) configuration that measures S₁₁, S₂₁.

²3-Port T/R measures 2-port S-parameters plus two-path, three-port measurements.

³DRA is Direct Receiver Access configuration for use in developing custom solutions.

...And, Scorpion is NOT limited to just S-parameters.

A single connection to Scorpion reveals the true performance of your RF device especially as your passive devices are integrated with active devices. This single instrument, consisting of both flexible models and powerful options, means you can design and manufacture all of your passive, active, mixer, power amplifier, and custom RF devices! For example, you

can also add any or all of the following options to your 2, 3, or 4-Port S-parameter engine: Time Domain, Noise Figure, Frequency Translating Group Delay (FTGD), Harmonics and Intermodulation Distortion (IMD). This integrated and compact measurement solution provides unparalleled performance, versatility and value for all of your RF

Scorpion MS462xx Vector Network Measurement System Product Overview

Model/Option	"A" Passive T/R1	"B" Active / Mixer Bal / Diff, 3-Port	"C" Antenna / Custom DRA2	"D" Bal / Diff 4-Port
10 MHz - 3 GHz (MS4622x)	✓	✓	✓	✓
10 MHz - 6 GHz (MS4623x)	✓	✓	✓	✓
10 MHz - 9 GHz (MS4624x)	✓	✓	✓	✓
Time Domain	✓	✓	✓	✓
Internal Second Source		✓	✓	Standard
50 MHz - 3 GHz NF 50 MHz - 6 GHz NF	Contact Factory	✓ ✓	✓ ✓	✓ ✓
Mixer Group Delay		✓	✓	✓
Third Port (No Source)	Contact Factory	✓		
Step Attenuator	✓	Standard	Standard	Standard
Harmonics	✓	✓	✓	✓
AutoCal Control	✓	✓	✓	✓
Connector Designation	✓	✓	✓	✓
Intermodulation Distortion		✓	✓	✓

¹T/R is economical Transmission/Reflection (or one-path, two-port) configuration that measures S₁₁, S₂₁.

²DRA is Direct Receiver Access configuration for use in developing custom solutions.

Technical Specifications

Technical Specifications and Configuration Guide for Scorpion are detailed in the following pages.

Test Conditions

The specifications in the following pages describe the warranted performance of the instrument at $23 \pm 3^{\circ}\text{C}$ when the unit

is calibrated with the appropriate AutoCal module or coaxial calibration kit. A warm-up time of ninety (90) minutes should

be allowed prior to verifying system specifications. Performance parameters denoted as “typical” indicate non-warranted specifications.

Test Port Corrected Characteristics

Connector	Configuration	Frequency (MHz)	Directivity (dB)	Source Match (dB)	Load Match (dB)
3.5 mm (MS4600/11S) (MS4600/11SF)	Ports 1 and 2 MS462xB MS462xD	10-1000	>46	>44	>46
		1000-3000	>44	>41	>44
		3000-6000	>38	>39	>38
		6000-9000	>37	>36	>37
	Ports 3 and 4 MS462xB/Opt3x MS462xD	10-1000	>44	>42	>44
		1000-3000	>42	>40	>42
		3000-6000	>37	>37	>37
		6000-9000	>36	>35	>36
N-Type Standard N(F) (MS4600/11NM)	Ports 1 and 2 MS462xB MS462xD	10-1000	>46	>44	>46
		1000-3000	>44	>41	>44
		3000-6000	>38	>39	>38
		6000-9000	>37	>36	>37
	Port 3 and 4 MS462xB/Opt3x MS462xD	10-1000	>44	>42	>44
		1000-3000	>42	>40	>42
		3000-6000	>37	>37	>37
		6000-9000	>36	>35	>36
GPC-7 (MS4600/11A)	Ports 1 and 2 MS462xB MS462xD	10-1000	>46	>44	>46
		1000-3000	>44	>41	>44
		3000-6000	>38	>39	>38
		6000-9000	>37	>36	>37
	Port 3 and 4 MS462xB/Opt3x MS462xD	10-1000	>44	>42	>44
		1000-3000	>42	>40	>42
		3000-6000	>37	>37	>37
		6000-9000	>36	>35	>36

(12-term error correction applied; 24-term error correction applied for Port 3; 40-term error correction applied for Port 4)

Frequency Range	Raw Directivity (All Models)	Raw Port Match (All Models)
10 MHz - 3 GHz	23 dB	15 dB*
3 GHz - 6 GHz	20 dB	15 dB
6 GHz - 9 GHz	15 dB	9 dB

*Ms462xD models with Option 4F or 4G degraded below 100 MHz

Dynamic Range

System Dynamic Range is defined as the differential between the power available at Port 1 and the system noise floor. The noise floor of the system is defined as the peak of the noise trace under the following conditions; terminating all test ports with broadband coaxial loads, applying full 12-term error correction and minimum (10 Hz) IF bandwidth with one average applied.

Models	Frequency (MHz)	Typical Port Power (dBm)	Noise Floor (dBm)	System Dynamic Range (dB)
MS4622A 3 GHz 2-Port T/R1	50	14	-100	114
	800	14	-115	129
	1900	14	-115	129
	3000	13	-115	128
MS4622B 3 GHz 2, 3-Port	50	12	-100	112
	800	12	-115	127
	1900	12	-115	127
	3000	11	-115	126
MS4622D 3 GHz 4-Port	50	12	-100	112
	800	12	-115	127
	1900	12	-115	127
MS4623A 6 GHz 2-Port T/R1	3000	11	-115	126
	50	13	-100	113
	1900	13	-115	128
	3000	13	-115	128
	6000	11	-105	116
MS4623B 6 GHz 2, 3-Port	50	11	-100	111
	1900	11	-115	126
	3000	11	-115	126
	6000	10	-105	115
MS4623D 6 GHz 4-Port	50	11	-100	111
	1900	11	-115	126
	3000	11	-115	126
	6000	10	-105	115
MS4624A 9 GHz 2, 3-Port T/R1	50	14	-100	114
	1900	14	-115	129
	3000	13	-115	128
	6000	12	-115	127
	9000	12	-105	117
MS4624B 9 GHz 2, 3-Port	50	12	-100	112
	1900	12	-115	127
	3000	11	-115	126
	6000	11	-115	126
	9000	11	-105	116
MS4624D 9 GHz 4-Port	50	12	-100	112
	1900	12	-115	127
	3000	11	-115	126
	6000	11	-115	126
	9000	11	-105	116

¹T/R is economical Transmission/Reflection (or one-path, two-port) configuration that measures S_{11} , S_{21} .

Source Specifications

The following source specifications apply to both the standard (Source 1) and optional (Source 2, reference Option 3x) sources within Scorpion.

Power Output Range:

Standard source output power ranges are summarized in the following table. Note that the source output power range is primarily affected in the 4-port configuration or when adding the option for Noise Figure (MS4600/4 or MS4600/4B).

Configuration	Model/Option	Frequency Range	Source 1	Source 2
2-Ports No Options	MS4622X ¹ MS4623X ¹ MS4624X ¹	10 MHz to 3 GHz 10 MHz to 6 GHz 10 MHz to 9 GHz	+10 to -85 dBm +7 to -85 dBm +7 to -85 dBm	N/A N/A N/A
3-Ports Without Noise Figure	MS4622B + MS4600/3B or 3D (2nd Internal Source)	10 MHz to 3 GHz	+10 to -85 dBm	+10 to -85 dBm
	MS4623B + MS4600/3E or 3F (2nd Internal Source)	10 MHz to 6 GHz	+7 to -85 dBm	+7 to -85 dBm
	MS4624B + MS4600/3E or 3F (2nd Internal Source)	10 MHz to 9 GHz	+7 to -85 dBm	+7 to -85 dBm
2, 3, or 4-Ports Add Noise Figure	MS4622B + MS4600/4 MS4623B + MS4600/4(B) MS4624B + MS4600/4(B) MS462xD + MS4600F MS462xD + MS4600G	Add 3 GHz NF ² Add 3 or 6 GHz NF ² Add 3 or 6 GHz NF ² Add 3 GHz NF ² Add 6 GHz NF ²	+7 to -85 dBm +5 to -85 dBm +5 to -85 dBm +5 to -85 dBm +5 to -85 dBm	No Change No Change No Change No Change No Change
4-Ports	MS4622D MS4623D MS4624D	10 MHz to 3 GHz 10 MHz to 6 GHz 10 MHz to 9 GHz	+10 to -85 dBm +7 to -85 dBm +7 to -85 dBm	+10 to -15 dBm +7 to -15 dBm +7 to -15 dBm

¹MS4622A and MS4623A source power includes optional step attenuator; otherwise lowest port power is -15 dBm.

²Noise Figure measurements start at 50 MHz.

Frequency Resolution: 1 Hz

Frequency Stability - Aging: <5x10⁻⁶ / year

Temperature: <5x10⁻⁶ over +15°C to +50°C

Power Control Range: >20 dB. The minimum absolute level for power sweep is -15 dBm while the maximum power output for a unit is typically +10 dBm, depending upon configuration.

Source Power Level: The source power (dBm) may be set from the front panel menu or via GPIB. Port 1 power level is settable from +10 dBm (on the simpler test sets, ranging to +5 dBm on the most complex) to -15 dBm with 0.01 dB resolution. In addition, the Port 1 (and Port 3) power may be attenuated in 10 dB steps using the internal 70 dB step attenuator. Port 3 step attenuator is not available in D models. Port 1 step attenuator is optional in A models.

Power Level Accuracy: ±1 dB to 6 GHz, ±1.5 dB to 9 GHz (no flat power calibration applied; full-band frequency sweep at -15 dBm, 0 dBm, and maximum rated power).

Level Test Port Power: The power, at all sweep frequencies, is leveled to within ±1dB to 6 GHz (±1.5 dB to 9 GHz). Only Port 1 and Port 3 (if installed) can be power calibrated.

Harmonics and Spurious (at Maximum Rated Power): <-25 dBc for MS4624x, <-30 dBc for all other models.

Sweep Type: Linear, CW, Marker, or N-Discrete point sweep.

Power Sweep Range: 20 dB (minimum)

Power Meter Correction: The MS462xx offers a user-selectable feature that corrects for test port power variations and slope on Port 1 (or Port 3 when the optional internal source is installed) using an external Anritsu ML2437A or ML2438A power meter. Power meter correction is available at a user-selectable power level, if it is within the power adjustment range of the internal source. Once the test port power has been flattened, its level may be changed within the remaining power adjustment range of the signal source.

Multiple Source Control Capability: Multiple Source Control capability allows a user to independently control the frequencies of up to four sources (two internal and two external or one internal and three external) and the receiver without the need for an external controller. The frequency ranges and output powers of each source may be independently specified. A frequency sweep may be comprised of up to five separate bands, each with independent source and receiver settings, for convenient testing of frequency translation devices such as mixers. Up to five sub-bands may be tested in one sweep. This feature enables users to easily test mixers, up/down converters, multipliers, and other frequency conversion devices. For more information, see Multiple Source Mode application note (p.n. 11410-00244).

Receiver Specifications

The following receiver specifications apply to standard receivers within Scorpion when terminating all test ports with broadband coaxial loads (excluding spurs and degradation below 50 MHz).

3 GHz (MS4622x) Models, Average Noise Level (I.F. Bandwidth = 10 Hz):

Frequency Range	MS4622A ^{1,2}	MS4622B ^{1,2}	MS4622C ^{1,3}	MS4622D ^{1,2}
10 MHz to 3 GHz (Typical)	-100 dBm (-115 dBm)	-100 dBm (-115 dBm)	-110 dBm (-120 dBm)	-100 dBm (-115 dBm)

¹Damage Level: >+30 dBm, >+23 dBm noise figure mode

²Maximum Input Level: +27 dBm, +20 dBm noise figure mode

³Maximum Input Level: +20 dBm

6 GHz (MS4623x) Models, Average Noise Level (I.F. Bandwidth = 10 Hz):

Frequency Range	MS4623A ^{1,2}	MS4623B ^{1,2}	MS4623C ^{1,3}	MS4623D ^{1,2}
10 MHz to 3 GHz (Typical)	-100 dBm (-115 dBm)	-100 dBm (-115 dBm)	-110 dBm (-120 dBm)	-100 dBm (-110 dBm)
3 GHz to 6 GHz (Typical)	-90 dBm (-105 dBm)	-90 dBm (-100 dBm)	-100 dBm (-110 dBm)	-90 dBm (-100 dBm)

¹Damage Level: >+30 dBm, >+23 dBm noise figure mode

²Maximum Input Level: +27 dBm, +20 dBm noise figure mode

³Maximum Input Level: +20 dBm

9 GHz (MS4624x) Models, Average Noise Level (I.F. Bandwidth = 10 Hz):

Frequency Range	MS4624A ^{1,2}	MS4624B ^{1,2}	MS4624C ^{1,2}	MS4624D ^{1,2}
10 MHz to 3 GHz (Typical)	-100 dBm (-115 dBm)	-100 dBm (-115 dBm)	-110 dBm (-120 dBm)	-100 dBm (-115 dBm)
3 GHz to 6 GHz (Typical)	-100 dBm (-115 dBm)	-100 dBm (-115 dBm)	-110 dBm (-120 dBm)	-100 dBm (-115 dBm)
6 GHz to 9 GHz (Typical)	-90 dBm (-105 dBm)	-90 dBm (-105 dBm)	-100 dBm (-110 dBm)	-90 dBm (-105 dBm)

¹Damage Level: > +30 dBm, > +23 dBm noise figure mode

²Maximum Input Level: +27 dBm, +20 dBm noise figure mode

³Maximum Input Level: +20 dBm

Measurement Enhancement

Data Averaging: Averaging of 1 to 4096 averages can be selected. The data averaging function is performed at each data point during the frequency sweep or sweep by sweep. Averaging can be toggled on/off via the front panel and a front panel LED indicates that the data averaging function is enabled.

30 kHz	10 kHz	3 kHz	1 kHz	300 Hz	100 Hz	30 Hz	10 Hz
--------	--------	-------	-------	--------	--------	-------	-------

IF Bandwidth: Soft Key selection of IF bandwidth; selections shown in the following table.

Trace Smoothing: Computes an average over a percentage range of the data trace. The percentage of trace to be smoothed can be selected from 0 to 20% of trace.

Measurement Capabilities

Parameters: S-Parameters (including Mixed-Mode on 3 and 4-port configurations), Harmonics, Noise Figure, Intermodulation Distortion (IMD), Frequency Translating Group Delay and user-defined combinations of a_1 , a_2 , a_3 , a_4 , b_1 , b_2 , b_3 and b_4 .

Balanced/Differential Measurement Configuration:

Depending upon the configuration, S-Parameters (including Mixed-Mode) that can be chosen from the front panel are shown in the following table.

Standard				Single Ended Balanced			Balanced/Balanced			
S_{11}	S_{12}	S_{13}	S_{14}	S_{11}	S_{1D}	S_{1C}	S_{D1D1}	S_{D1D2}	S_{D1C1}	S_{D1C2}
S_{21}	S_{22}	S_{23}	S_{24}	S_{D1}	S_{DD}	S_{DC}	S_{D2D1}	S_{D2D2}	S_{D2C1}	S_{D2C2}
S_{31}	S_{32}	S_{33}	S_{34}	S_{C1}	S_{CD}	S_{CC}	S_{C1D1}	S_{C1D2}	S_{C1C1}	S_{C1C2}
S_{41}	S_{42}	S_{43}	S_{44}				S_{C2D1}	S_{C2D2}	S_{C2C1}	S_{C2C2}

The following pictures illustrate how 3 and 4-port devices are connected to Scorpion for balanced / differential measurements and the relationship to the virtual ports for mixed-mode S-Parameters.

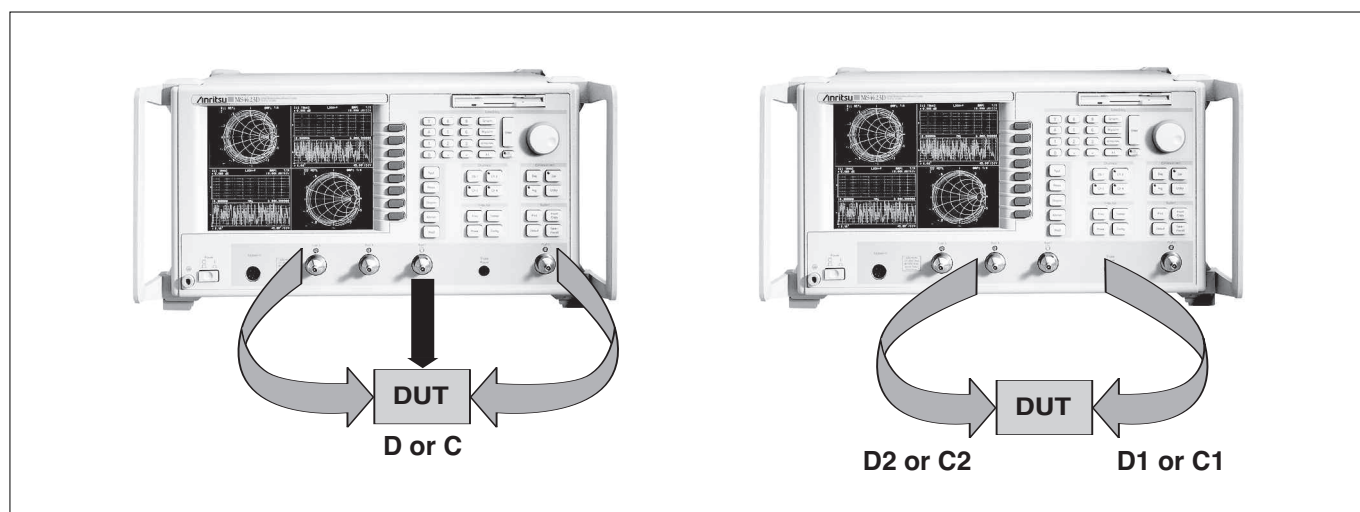

Measurement of 3 and 4-port single ended S-parameters are required in order to perform the mixed-mode conversion, which generates results as if the ports were being driven in pairs.

For more information, see Three and Four Port S-Parameter Measurements application note (p.n. 11410-00279).

Time Domain (MS4600/2)

High Speed Time (Distance) Domain software allows the conversion of reflection or transmission measurements from the frequency domain to the time domain. Time domain analysis can also be performed utilizing Lowpass, Bandpass or Phasor Impulse processing techniques. Windows and Gating support additional conditioning to further enhance time domain processing.

For more information, see Time Domain application note (p.n. 11410-00206)

Embedding/De-Embedding

The MS462xx incorporates a variety of standard embedding and de-embedding functions and some utilities to make this task easier. As shown in the following simplified block diagrams, the MS462xx can (depending upon the configuration) remove the effects of networks (ntwk) or virtually add in the effects of other networks (e.g., matching) for 2, 3 or 4-port devices. Network elements can consist of transmission lines, L-C circuit primitives and SnP data files (some examples are shown). Multiple cascading of network elements is supported.

For more information, see Embedding/De-Embedding application note (p.n. 11410-00278).

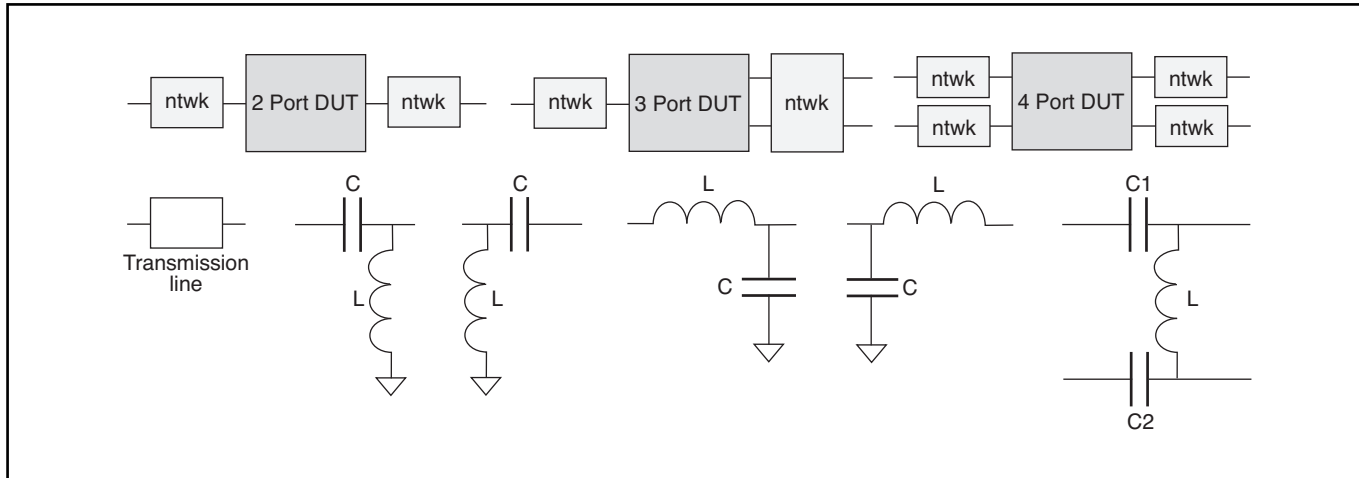

Arbitrary Impedance Transformations

Standard firmware feature to perform the calibration in a 50 ohm world (using conventional calibration kits) and then transform the resulting measurement data to what it would look like if calibrated in some other arbitrary impedance environment. This feature allows measurements to be presented as if performed in the desired impedance (typically between a few ohms and 1000 ohms). Impedance can be specified in both real and imaginary terms for every port. Impedances can be specified as complex numbers.

For more information, see Arbitrary Impedance application note (p.n. 11410-00284).

Network Extraction

Standard firmware utility that determines S-parameters of a test fixture from a pair of calibrations: one calibration at the coaxial plane and the other calibration at the DUT plane with the fixture in place. Output is a *.S2P file for every port.

For more information, see Embedding/De-Embedding application note (p.n. 11410-00278).

Interchannel Math

Calculations (primarily division) can be performed between two channels. These calculations are typically used to calculate amplitude and phase imbalance of balanced/differential structures.

For more information, see Three and Four Port S-Parameter Measurements application note (p.n. 11410-00279).

Innovative Measurement Capabilities

NOISE FIGURE (MS4600/4x)

Frequency Range	Part Number
50 MHz – 3 GHz	MS4600/4, 4D, 4F
50 MHz – 6 GHz	MS4600/4B, 4E, 4G

Bandwidth: Selections are provided between Wide (>4 MHz) and Narrow (<250 kHz).

Display Selections: Noise Figure, Y-Factor, Insertion Gain, Available Gain and Equivalent Noise Temperature.

Loss Compensation: Loss Before DUT, Loss After DUT and various S2P data files are supported.

Noise Source Locations: Noise Source (not included) can be connected either externally or internally, where the rear panel connection provides a path to Port 1 of Scorpion. Factory created EXT file (consisting of S2P and S1P data) for this path is provided.

Noise +28V: Rear panel BNC female connector supplying pulsed drive for noise diode.

Instrumentation Uncertainty: ±0.15 dB

For more information, see the following Noise Figure application notes:

Noise Figure (p.n. 11410-00210)

Noise Figure Corrections (p.n. 11410-00256)

Noise Figure Accuracy (p.n. 11410-00227)

Intermodulation Distortion (IMD, MS4600/3x, MS4600/13)

Frequency	Model/Option	Source 1 (dBm)	Source 2 (dBm)
10 MHz to 3 GHz	MS4622B + MS4600/3A + MS4600/13 MS4622C + MS4600/3C + MS4600/13 MS4622D + MS4600/13 ¹	+10 to -85 ²	+10 to -85
10 MHz to 6 GHz	MS4623B + MS4600/3B + MS4600/13 MS4623C + MS4600/3D + MS4600/13 MS4623D + MS4600/13 ¹	+7 to -85 ²	+7 to -85
10 MHz to 9 GHz	MS4624B + MS4600/3E + MS4600/13 MS4624C + MS4600/3F + MS4600/13 MS4624D + MS4600/13 ¹	+7 to -85 ²	+7 to -85

¹Source 2 step attenuator not available in D models; port 3 lowest power is -15 dBm.

²When using Noise Figure (MS4600/4 or MS4600/4B), Source 1 power is reduced to +5 dBm.

Display Selections: Intermodulation Distortion Products (IMD, dBc) and Third Order Intercept Calculations (TOI, dBm) for third, fifth, seventh and ninth order products. Selections are also provided for: Upper and/or Lower Products, Input or Output Referred and CW, Swept Frequency or Swept Power. Second Order Intercept measurements can be performed using Multiple Source Control.

Accuracy: ±1 dB (levels >-60dBm, 10 Hz BW)

Dynamic Range: (receiver main tones = -10 dBm, 10 Hz BW)

Offset > 300 kHz.....-80 dBc

Typical Dynamic Range (with combiner network of sufficient isolation):

-85 to -100 dBc for tone-spacing of 500 kHz

-100 dBc or lower for tone-spacing of 2 MHz

For more information, see Intermodulation Distortion (IMD) application note (p.n. 11410-00213).

Harmonic Measurement (MS4600/8)

Frequency Range	Model/Option	Source 1 (dBm)	Harmonic Number
10 MHz – 3 GHz	MS4622x + MS4600/8	+10 to -851	Fundamental, second, third, fourth, fifth, sixth, seventh, eighth, and ninth. Frequency Limited by Model
10 MHz – 6 GHz	MS4623x + MS4600/8	+7 to -851	
10 MHz – 9 GHz	MS4624x + MS4600/8	+7 to -851	

¹When using Noise Figure (MS4600/4 or MS4600/4B), Source 1 power is reduced to +5 dBm.

Display Selections: For harmonics (Fundamental, second, third, fourth, fifth, sixth, seventh, eighth, and ninth), select relative to (dBc) Output Harmonic or Source Harmonic. Selections are also provided for CW, Swept Frequency or Swept Power measurements.

Correction: Enhancement calibration enables measurement of magnitude and phase for second and third harmonics.

For more information, see Harmonic Measurements application note (p.n. 11410-00222).

Accuracy (level of harmonic at receiver above -40 dBm):

Scalar Accuracy and Setup	Dynamic Range
Scalar ±1 dB source power @ DUT <-10 dBm fundamental power @ receiver <0 dBm	30 dB Typical
Vector Enhancement and Setup	Dynamic Range
Vector ±1 dB fundamental power @ receiver <+10 dBm	50 dB Typical

Frequency Translating Group Delay (FTGD), (MS4600/5)

FTGD allows the measurement of group delay of mixers and other translating devices by analyzing the phase shift experienced by a modulated signal (generated internally). The Group Delay is measured by computing the phase change across a frequency interval using the formula, $\tau_g = -(\text{phase (deg.)}) / \{360 \cdot (\text{frequency (Hz)})\}$ applies except the phase change is measured across the modulating bandwidth of the test signal instead of across frequency points. The aperture is fixed at about 900 kHz and the range is limited to about 1 μ s. The use of angle modulation keeps the measurement relatively immune from compression and other non-linearities.

Frequency Range	Model/Option
10 MHz to 3 GHz	MS4622x + MS4600/5
10 MHz to 6 GHz	MS4623x + MS4600/5
10 MHz to 9 GHz	MS4624x + MS4600/5

Display Selections: Conversion Loss (or Gain), Group Delay and Phase.

For more information, see Frequency Translating Group Delay application note (p.n. 11410-00236).

Power Sweep Measurements

Standard, easy-to-use Swept Power Gain Compression (SPGC) and Swept Frequency Gain Compression (SFGC) modes are available. Additional standard power sweep features are available for S-parameters, Intermodulation Distortion, Harmonics and mixer measurements.

For more information, see Global Power Sweep application note (p.n. 11410-00243).

Measurement Sweep Speed Summary

Measurement times are measured using a single trace (S21) display and one average (no correction is applied). The measurement speeds for the communications band are measured in a 25 MHz band from 824 - 849 MHz. The typical measurement times observed are as follows:

Data Points	IF Bandwidth (Hz)	10 MHz - 3 GHz (ms)	10 MHz - 6 GHz (ms)	10 MHz - 9 GHz (ms)	Communications Band (ms)
51	30 kHz	16	18	31	11
	10 kHz	21	23	35	16
	3 kHz	32	35	46	27
	1 kHz	66	69	76	61
	300 Hz	187	189	203	184
101	30 kHz	26	28	40	20
	10 kHz	35	38	48	28
	3 kHz	57	60	71	50
	1 kHz	126	129	138	120
	300 Hz	366	370	380	368
201	30 kHz	44	48	64	37
	10 kHz	61	65	81	52
	3 kHz	106	110	126	98
	1 kHz	242	246	262	234
	300 Hz	716	720	740	712
401	30 kHz	80	87	110	70
	10 kHz	114	121	146	104
	3 kHz	206	212	236	196
	1 kHz	480	484	508	468
	300 Hz	1424	1432	1448	1408
801	30 kHz	150	161	202	130
	10 kHz	218	230	270	198
	3 kHz	400	412	456	380
	1 kHz	952	960	1000	928
	300 Hz	2820	2840	2900	2800

Corrected Sweep Speed Performance

Corrected Measurement times are measured using a single trace (S21) display and one average in the communications band, which is measured in a 25 MHz band from 824 - 849 MHz. The typical measurement times for the various n-port configurations are as follows:

Data Points	IF Bandwidth (Hz)	2-Port (ms)	3-Port (ms)	4-Port (ms)
401	30 kHz	308	752	1640
	10 kHz	432	1040	2040
	3 kHz	796	1840	3480

GPIB Data Collection Summary

This section summarizes typical data collection times for automated measurements using the MS462xx's IEEE 488.2 GPIB bus. Throughput measurement times for both tables include triggering and waiting for a full sweep and transferring data across the GPIB bus. Data throughput times are shown separately for measurements made without calibration and with full two-port, 12-term calibration.

Byte Transfer Rate: >100 Kbytes/second

Single Marker Readout: <15 msec

201 Point Real/Imaginary Data Pair Readout: <(15 msec + sweep time)

Measurement Conditions: Instrument setup is 10 MHz to 3 GHz sweep, single channel, single graph (log mag) display, 30 kHz IF bandwidth, no averaging, no markers, no limit lines.

Typical Throughput Times (ms) without Correction

Data Format	3 Points	51 Points	101 Points	201 Points	401 Points	1601 Points
32 Bit	10	20	40	50	111	381
64 Bit	10	20	30	60	110	391
ASCII	10	61	90	180	361	1382

Typical Throughput Times (ms) with 12-term Correction

Data Format	3 Points	51 Points	101 Points	201 Points	401 Points	1601 Points
32 Bit	10	80	141	250	450	1582
64 Bit	10	80	140	241	460	1582
ASCII	20	111	200	371	701	2574

GPIB Interface - Two Connectors

System GPIB (IEEE-488.2): Connects to an external controller for use in remote programming of the network analyzer. Address can be set from the front panel and can range from 1 to 30.

Dedicated GPIB: Connects to external peripherals for network analyzer controlled operations (e.g. GPIB plotters, frequency counters, frequency synthesizers, and power meters).

GPIB Pass Thru Mode: Allows users to control equipment that is connected to Scorpion via the Dedicated GPIB interface.

Interface Function Codes: SH1, AH1, T6, TE0, L4, LE0, SR1, RL1, PP1, DT1, DC0, and C0.

GPIB Data Transfer Formats: ASCII, 32-bit floating point, or 64-bit floating point. 32-bit and 64-bit floating point data can be transferred with LSB or MSB first. When using Language Support Mode, most of the output formats of the 8753 will be supported, except for the hp internal binary data array format.

Burst Data Collection Modes: Fast CW and Data collection modes allow high speed collection of data for subsequent GPIB transfer.

Vector Error Correction

There are four methods of calibration:

- 1) Open-Short-Load (OSL) calibration method using short circuits, open circuits, and terminations (fixed or sliding)
- 2) Offset-Short (waveguide) calibration
- 3) LRL/LRM - Line-Reflect-Line or Line-Reflect-Match calibration
- 4) TRM - Thru-Reflect-Match calibration
- 5) SOLR - Short-Open-Load-Reciprocal

There are seven vector error correction models available:

- 1) Full 12-Term (2 Ports)
- 2) Full 24-Term (3 Ports)
- 3) Full 40-Term (4-Ports)
- 4) One Path/Two Port
- 5) Two Path/Three Port
- 6) Frequency Response (Transmission/Reflection)
- 7) Reflection Only

Full 12-term can be used on the fully reversing models MS462xB, MS462xC (depending on the test set) and MS462xD only. Full 24-Term can be used on the 3-port models (MS462xB with MS4600/3x). Full 40-Term can be used on the 4-port models (MS462xD). Front-panel display indicates the type of calibration stored in memory. Front-panel button selects whether calibration

is to be applied, and the Cal LED illuminates when error correction is being applied.

Flexible Cal™

Optimize throughput by performing only the sweeps required to characterize multi-port devices. Also enables convenient switching between 2, 3 and 4-port calibrations without re-calibration.

Calibration Sequence

Prompts the user to connect the appropriate calibration standard to Port 1 and/or Port 2 and/or Port 3 and/or Port 4.

Calibration Standards

For coaxial calibrations the user selects SMA, GPC-3.5, GPC-7, Type N, 2.4 mm, TNC, 7/16, N-75 or K Connector from a calibration menu. Use of fixed or sliding loads can be selected for each connector type. Open circuit capacitance coefficients can

be modified. Short circuit offset length may be modified. Inductance values for the shorts and terminations may be modified. In general, all calibration parameters may be modified manually or through the GPIB interface.

Reference Impedance

Modify the reference impedance of the measurement to other than 50 ohms (but positive).

LRL/LRM Calibration Capability

The LRL calibration technique uses the characteristic impedance of a length of transmission line as the calibration standard. A full LRL calibration consists merely of two transmission line measurements, a high reflection measurement, and an isolation measurement. The LRM calibration technique is a variation of the LRL technique that utilizes a precision termination rather than a second length of transmission line. A third optional standard, either Line or Match, may be measured in order to extend the

frequency range of the calibration. This extended calibration is achieved by mathematically concatenating either two LRL, two LRM, or one LRL and one LRM calibration(s). Using these techniques, full 12-term error correction can be performed on the MS462xB, MS62xC, or MS462xD, refer to B, C, and D.

SOLR Calibration Capability

SOLR is a hybrid of SOLT and LRL/LRM techniques in which defined reflection standards are used but the “thru” can be imperfect. In cases where the “thru” is not lossless or not perfectly matched (which the other algorithms assume to some degrees), SOLR may be a good choice. The only requirement is that it be reciprocal (i.e., $S_{21}=S_{12}$).

Dispersion Compensation

Selectable as Coaxial (non-dispersive), Waveguide, or Microstrip (dispersive).

Reference Plane

Selectable as Middle of line 1 or Ends of line 1.

AutoCal

The MS462xx incorporates internal control of the 3658x-series AutoCal modules, including the new 4-port module, as a standard feature.

For more information, see the following AutoCal related literature:

3658 Series AutoCal VNA 2-Port Automatic Calibrators Brochure (p/n: 11410-00189)

AutoCal Automatic Calibrator Application Note (p/n: 11410-00258)

3658 Series AutoCal VNA 4-Port Automatic Calibrators Brochure (p/n: 11410-00294)

4-Port AutoCal Automatic Calibrator Application Note (p/n: 11410-00298)

Measurement Frequency Range: Frequency range of measurement can be narrowed within the calibration range without recalibration. CW mode permits single frequency measurements, also without recalibration. In addition, the system accepts N discrete frequency points where $2 < N < 1601$.

Domains: Frequency Domain, CW Draw, and optional High Speed Time (Distance) Domain.

Formats: Log Magnitude, Phase, Log Magnitude and Phase, Smith Chart (Impedance), Smith Chart (Admittance), Linear Polar, Log Polar, Group Delay, Linear Magnitude, Linear Magnitude and Phase, Real, Imaginary, Real and Imaginary, SWR, and Power.

Group Delay: Group Delay is measured by computing the phase change across a frequency interval using the formula, $\tau_g = -(\text{phase (deg.)}) / \{360 \cdot (\text{frequency (Hz)})\}$

Aperture: Defined as the frequency interval over which the phase change is computed at a given frequency point. The aperture can be changed without recalibration. The minimum aperture is the frequency span divided by the number of points while the maximum is 20% of the span. A larger aperture can be considered equivalent to increased smoothing.

Range: The maximum delay range corresponds to ± 180 degrees of phase change over a frequency step. A step of 100 kHz corresponds to a maximum delay of 10 μ s.

Data Points: 1601 maximum. Number of data points can be switched to a value of 801, 401, 201, 101, 51, 15, or 3 points without recalibration (if 1601 points were used in the calibration).

Standard Measurements	1	3	15	51	101	201	401	801	1601	2 < Discrete < 1601
3-Port Balanced/Differential	1	3	15	51	101	201	401	801	1601	2 < Discrete < 401
4-Port Balanced/Differential	1	3	15	51	101	201	401	801	1601	2 < Discrete < 1601

In addition, the system accepts an arbitrary set of N discrete data points where: $2 < N < 1601$. CW mode permits selection of a single data point without recalibration.

Reference Delay: Can be entered in time or in distance (when the dielectric constant is entered). Automatic reference delay feature adds the correct electrical length compensation at the push of a button. Software compensation for the electrical length difference between reference and test is always accurate and stable since measurement frequencies are always synthesized. In addition, the system compensates reference phase delay for dispersive transmission media such as microstrip. Delay information can be saved to output file types.

Alternate Sweep: Allows the capability to decouple channel 1 and 2 from channel 3 and 4 for the following parameters: correction type, start and stop frequencies, number of data points, markers, sweep time, averaging, smoothing and IF bandwidth. Operation of alternate sweep is not compatible with the following modes: Multiple source, power sweep, gain compression, time domain, and adapter removal.

Tune Mode: Tune Mode optimizes sweep speed in tuning applications by updating forward S-parameters more frequently than reverse ones. This mode allows the user to select the ratio of forward sweeps to reverse sweeps after a full 12-term calibration. The ratio of forward sweeps to reverse sweeps can be set anywhere between 1:1 to 10,000:1.

Sequencing: Up to seven measurement sequences can be created, stored, edited, and run from the front panel. Sequences can include front panel functions as well as user definable control statements. Sequences can be run from either the unit front panel, via GPIB, or from an AT-style keyboard plugged into the front panel.

Display Capabilities

Display Channels: Four, each of which can display any S-parameter or user defined parameter in any format with up to two traces per channel for a maximum of eight traces simultaneously. Each channel is also capable of displaying harmonics, noise figure, intermodulation distortion, or time domain trace. A single channel, two channels (1 and 3, or 2 and 4), or all four channels can be displayed simultaneously. Channels 1 and 3, or channels 2 and 4 can be overlaid for rectilinear graph types.

Display Groups (For MS462xD Models only): Four groups of four channels for a total of sixteen displays, with only four channels displayed at a time. Each channel can display any S-parameter in any format as described in Display Channels previously. Display groups are selected with front panel channel-selection keys (C 1, Ch 2, Ch 3, and Ch 4).

Liquid Crystal Display: A Color 8.4" Thin Film Transistor (TFT) LCD display is standard on all units. The default color configuration is as follows: graticules are displayed in green, measurement data in red, background in black, markers and limits in blue, and overlaid trace data in yellow. Trace data stored in memory are displayed in green.

Trace Color: The color of display traces, memory, text, markers, background color, and limit lines are all user definable.

Trace Overlay: Displays four data traces on the active channel's graticule simultaneously. The overlaid trace is displayed in yellow and the primary trace is displayed in red.

Trace Memory: A separate memory for each channel can be used to store measurement data for later display or subtraction, addition, multiplication or division with current measurement data.

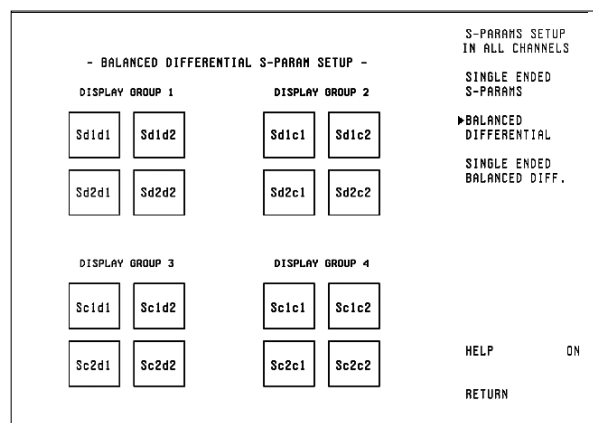

Markers: Twelve independent markers can be used to read out simultaneous measurement data. In alternate sweep mode there are sets of markers for each frequency sweep. In delta-reference marker mode, any one marker can be selected as the reference for the other eleven. Markers can be directed automatically to the minimum or maximum of a data trace.

Enhanced Markers: Marker search for a level or bandwidth, displaying an active marker for each channel, and discrete or continuous (interpolated) markers. Identifies the X dB bandwidth and ripple of amplifiers, filters and other frequency sensitive devices.

Marker Sweep: Sweeps upward in frequency between any two markers. Recalibration is not required during the marker sweep.

Segmented Sweep: Up to 16 segments and a total of 1601 data points. T/R measurements only.

Limit Lines: Either single or segmented limit lines can be displayed. Two limit lines are available for each trace.

Single Limit Readouts: Interpolation algorithm determines the exact intersection frequencies of data traces and limit lines.

Segmented Limit Lines: A total of 20 segments (10 upper and 10 lower) can be generated per data trace. Complete segmented traces can be offset in both frequency and amplitude.

Test Limits: Both single and segmented limits can be used for PASS/FAIL testing. PASS or FAIL status is indicated on the display after each sweep. In addition, PASS/FAIL status is output through the rear panel I/O connector as selectable TTL levels (PASS=0V, FAIL=+5V, or PASS=+5V, FAIL=0V).

Scale Resolution (minimum):

Log Magnitude: 0.001 dB/div **Linear Magnitude:** 1 pU

Phase: 0.01° **Group Delay:** 0.001 ps

Time: 0.001 ms **Distance:** 0.1 mm

SWR: 1 pU **Power:** 0.01 dB

Autoscale: Automatically sets resolution and offset to fully display measurement data

Reference Position: Can be set at any graticule line.

Annotation: Type of measurement, vertical and horizontal scale resolution, start/stop or center/span frequencies, and reference position.

Blank Frequency Information: Blanking function removes all references to displayed frequencies on the LCD. Frequency blanking can only be restored through a system reset or GPIB command.

Hard Copy

Printer: Menu selects full screen graphical, tabular data, *.SnP (S1P, S2P, S3P, or S4P), *.MnP (M3P or M4P consisting of mixed-mode S-parameters), or *.txt output, and printer type. The number of data points of tabular data can be selected as well as data at markers only.

The MS462XX series will support the same printers as the Anritsu 37000 family of network analyzers, which currently include the HP 2225C InkJet, HP QuietJet, HP DeskJet, HP LaserJet II, III, IV, and V Series, and Epson compatible printers with Parallel (Centronics) interfaces. Compatible with ANRITSU "CAP3700" program (outputs bitmap file over GPIB) and provide bitmap output over front panel to disk.

GPIB Plotters: The MS462xx series will support the same plotters as the Anritsu 37000 family of network analyzers, which currently include HP Models 7440A, 7470A, and 7475A, and Tektronix Model HC100 plotters. Menu selects plotting of full or user-selected portions of graphical data. The plotter is connected to the dedicated GPIB bus.

Performance: After selecting the Start Print button, front panel operation and measurement capability is restored to the user within 2 seconds.

Storage

Internal Memory: Ten front panel states (setup/calibration) can be stored and recalled from non-volatile memory locations. The current front panel setup is automatically stored in non-volatile memory at instrument power-down. When power is applied, the instrument returns to its last front panel setup. The system will be able to exchange two stored calibrations in less than 0.5 seconds.

Internal Non-Volatile Memory: Used to store and recall measurement and calibration data and front-panel setups. All files are MS-DOS compatible. File names can be 1 to 8 characters long, and must begin with a character, not a number. Extensions are automatically assigned. SCSI-2 drive support not operational when Option 15, internal 500 MB hard drive is installed.

Internal Hard Drive: Option 15, increases the size of the internal hard drive to 500MB.

Internal Floppy Disk Drive: A 3.5-inch diskette drive with 1.44 Mbytes formatted capacity is used to load measurement programs and to store and recall measurement and calibration data and front panel setups. All files are MS-DOS compatible. File names can be 1 to 8 characters long, and must begin with a character, not a number. Extensions are automatically assigned.

Measurement Data Size: 102.8 kbytes per 1601 point S-parameter data file.

Calibration Data Size: 187.3 kbytes per 1601 point S-parameter data file (12-term cal plus setup).

Trace Memory File Size: 12.8 kbytes per 1601 point channel.

External SCSI-2 Drive Support: Additional storage space is permitted through the use of an external SCSI-2 drive. When attached, the internal storage space is removed when using the external storage. Exchanging two stored calibrations becomes dependent on the performance of the external drive. SCSI Drive Support is not operational when Option 15, internal 500 MB hard drive is installed.

General

Front Panel Connectors and Controls:

Standard Test Port: N female

Optional Connector Types: 3.5mm female (MS4600/11SF), 3.5mm male (MS4600/11S), GPC-7 (MS4600/11A) and N male (MS4600/11NM)

Probe Power: -12, +15V, and GND; resettable fuse protected; HP 85024 compatible connector

External Keyboard: An IBM-AT compatible keyboard can be connected to the front panel for navigating through front panel menus, annotation of data files and display labels, printing displays and pausing instrument sweeps.

Rear Panel Connectors and Controls:

Printer: Standard 25-pin IBM PC interface for an external parallel port printer.

Line Selection: Power supply automatically senses 85V, 120V, 220V or 240V lines.

IEEE 488.2 GPIB: Standard IEEE488.2 GPIB interface. Connection for instrument controller

Dedicated GPIB: Standard IEEE488.2 GPIB interface. Connection for external source(s), plotters, or power meter

Serial Port: 15-pin male RS232 interface; connection for AutoCal module

SCSI-2: 50-pin female "D" Type Micro-Miniature interface

Ethernet: 15-pin female IEEE802.3 interface (Contact factory for RJ-45 Adapter)

VGA: Standard 15-pin female VGA interface

Noise +28V: BNC female connector supplying pulsed drive for noise diode

Noise Input: K female input connector from noise diode output

External Source Input: K female

External I/O: 15-pin D-sub connector to support Limits (pass/fail) information

P1 Bias T Fuse: 0.5A fuseholder for Port 1 Bias T

P2 Bias T Fuse (Not Available on MS462xA Models): 0.5A fuseholder for Port 2 Bias T

The following connectors are all BNC female:

External Trigger: External triggering for MS462XX measurement, $\pm 1V$ trigger 10k ohm input impedance.

External Analog Out: -10V to +10V with 5 mV resolution, varying in proportion to user-selected data (e.g., frequency, amplitude).

External Analog In: ± 50 volt input for displaying external signals on the LCD display in Diagnostics mode.

10 MHz Ref In: Connects to external reference frequency standard, 10 MHz, +5 to -5 dBm, 50 ohms.

P1 Bias T: 0.5A maximum, 40V DC maximum

P2 Bias T (Not Available on MS462xA Models): 0.5A maximum, 40V DC maximum

Power Requirements: 85-240V, 48-63Hz, 540 VA maximum

Dimensions: 222H x 425W x 450D mm (8.75 x 16.75 x 17.75 in.)

Weight: Ranges between 16 kg (35 lb.) for a MS4622A with no options installed and 23 kg (52 lb.) for a MS4624D with all options installed.

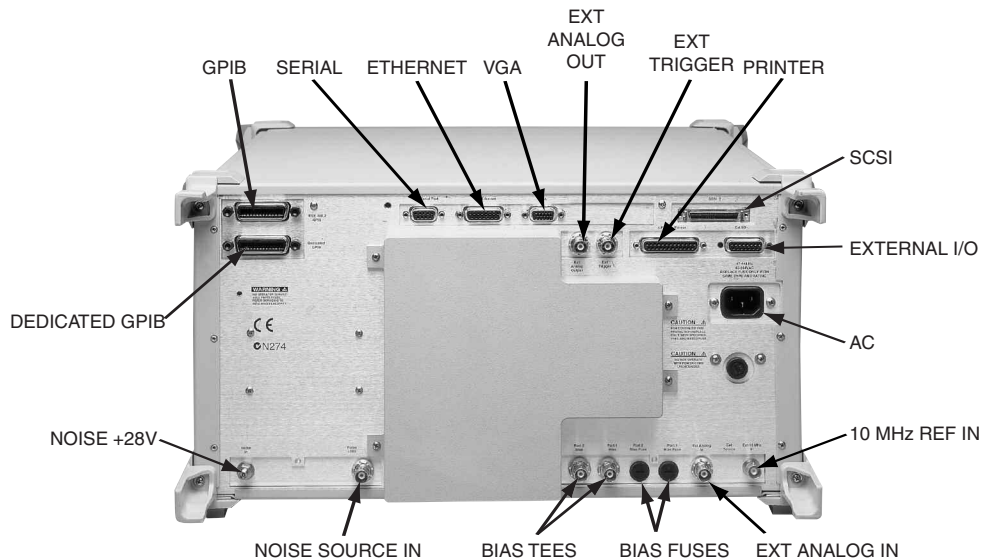

Environment

Storage Temperature Range: -40° to $+75^{\circ}\text{C}$

Operating Temperature Range: 0°C to $+50^{\circ}\text{C}$ (specifications apply at $23 \pm 3^{\circ}\text{C}$)

Relative Humidity: 5% to 95% at $+40^{\circ}\text{C}$

EMC

Meets the emissions and immunity requirements of: EMC Directive - 89/336/EEC per EN61326

Emissions Standard:

EN55011:1991

IEC 61000-3-2

IEC 61000-3-3

Immunity Standard:

IEC 1000-4-2:1995

IEC 1000-4-3:1995

IEC 1000-4-4:1995

IEC 1000-4-5:1995

IEC 1000-4-6:1995

IEC 1000-4-8:1995

IEC 1000-4-11:1995

Safety

Meets safety requirements of Low Voltage/Safety Standard: 72/23/EEC - EN61010-1:1993

Measurement Uncertainty

Exact Uncertainty is a Windows based program (Model No. 2300-361) that is available to help you obtain the uncertainty data that is appropriate for your specific setup conditions. An example of the basic configuration window is shown here to illustrate the intuitive graphical user interface. You can select the Anritsu VNA and the calibration kit being used as well as the frequency range of interest. Specified performance parameters are automatically included to simplify the calculations. This utility enables users to meet the uncertainty analysis requirements of the ISO standards.

The uncertainty curves in the following pages were generated using the utility.

Uncertainty Models includes the important VNA effective parameters, test configuration parameters such as connector and cable performance and Device Under Test (DUT) parameters. The model leads to equations that are quite elaborate. For more explanation of uncertainties, models and Exact Uncertainty, see the following application notes:

What is Your Measurement Accuracy (p/n: 11410-00270), Reflectometer Measurements-Revisited (p/n: 11410-00214).

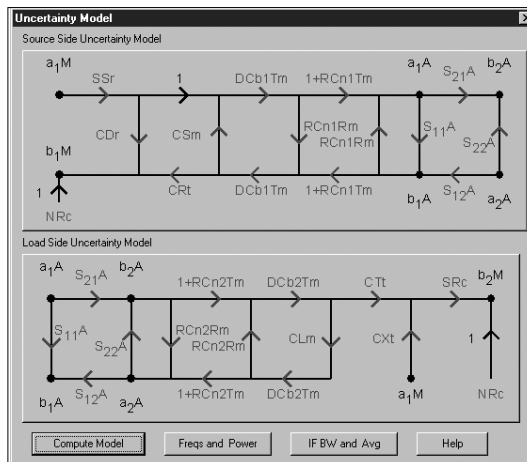
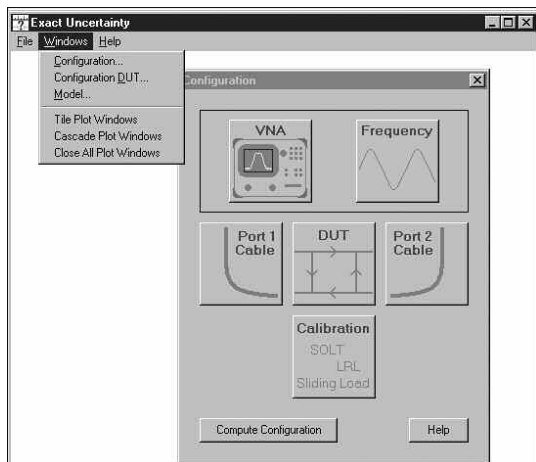

Uncertainty Graphs

The following graphs give measurement accuracy after 12-term vector error correction for N, 3.5 mm and GPC-7 connector types. The errors are worst case contributions of residual directivity, load and source match, frequency response, isolation, network analyzer dynamic accuracy, and connector repeatability.

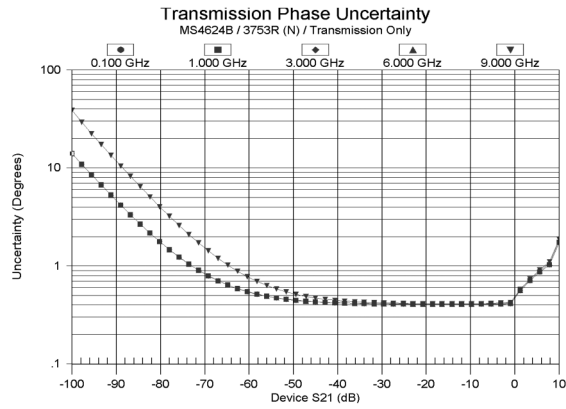
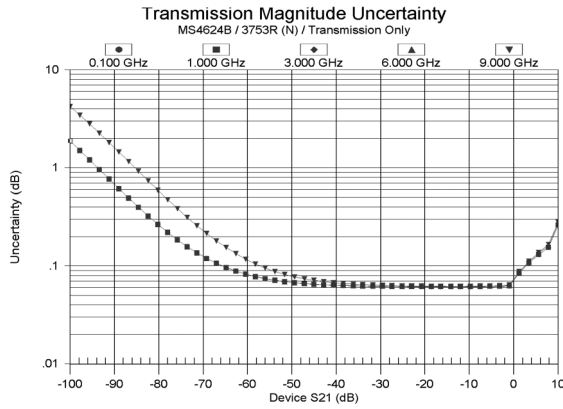

Transmission Measurements: N Connectors

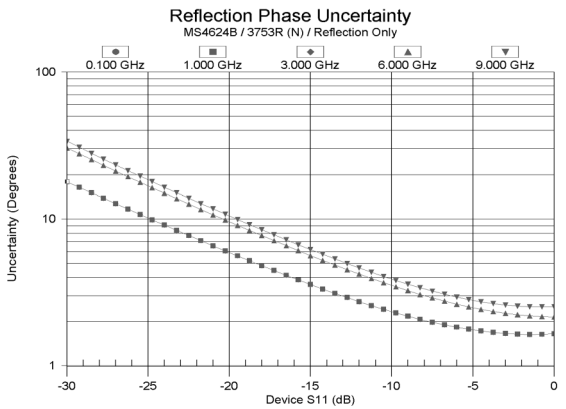
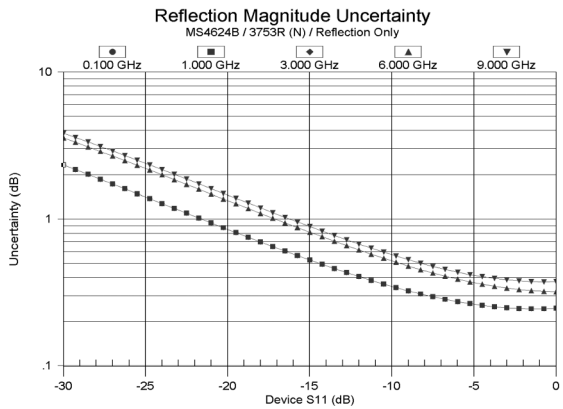

Reflection Measurements: N Connectors

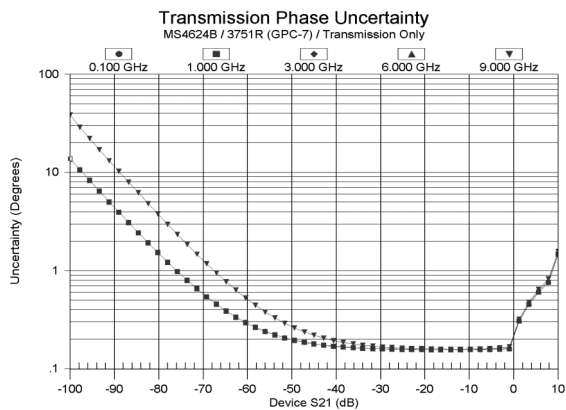
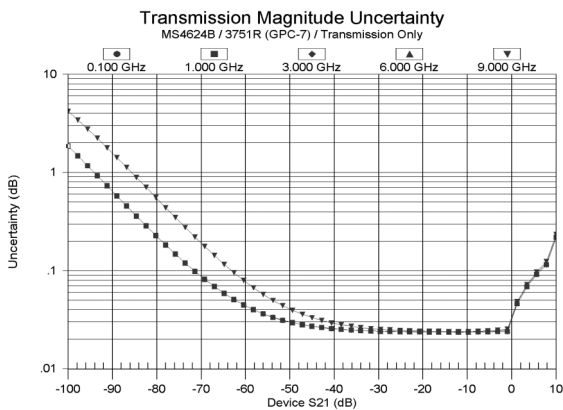

Transmission Measurements: GPC-7 Connectors

Uncertainty Graphs

In preparing the graphs on these two pages, a 10 Hz IF bandwidth and one averaging point were used following a calibration using 0 dBm Port Power. A 375xR series cal kit was used to obtain this data, which was generated using the Exact Uncertainty utility. Changes in the IF bandwidth or averaging can result in variations at low levels.

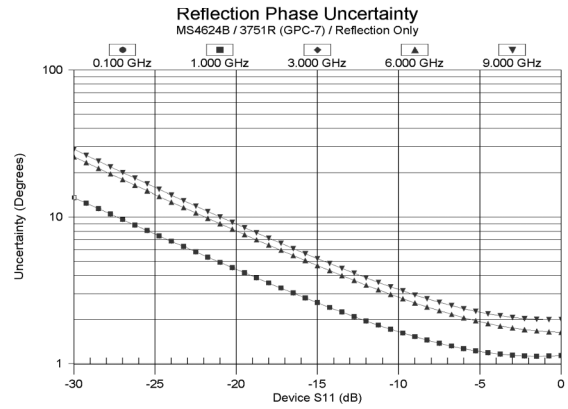
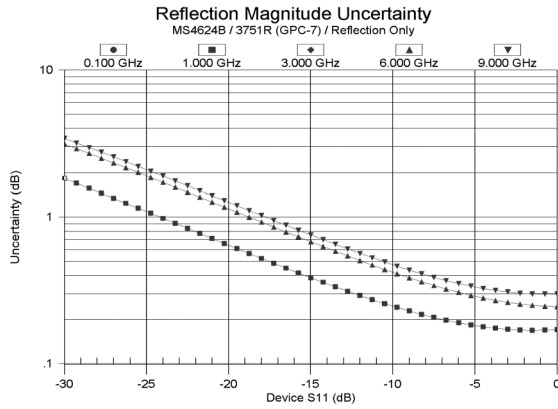

Reflection Measurements: GPC-7 Connectors

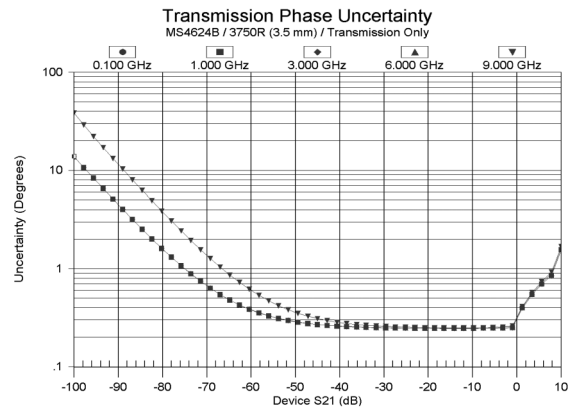
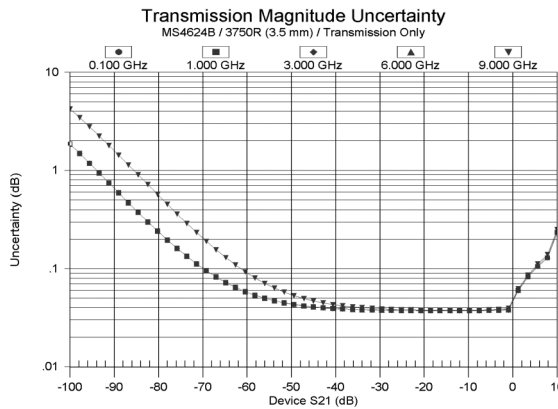

Transmission Measurements: 3.5 mm Connectors

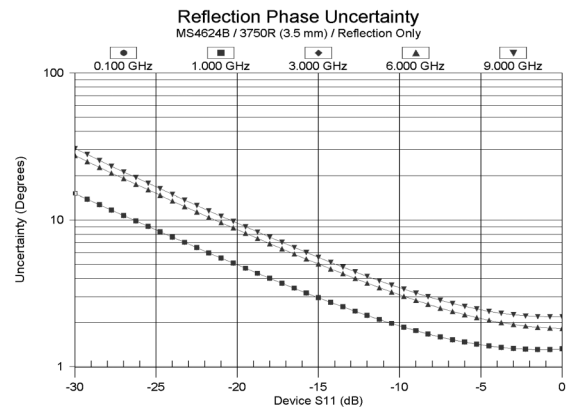
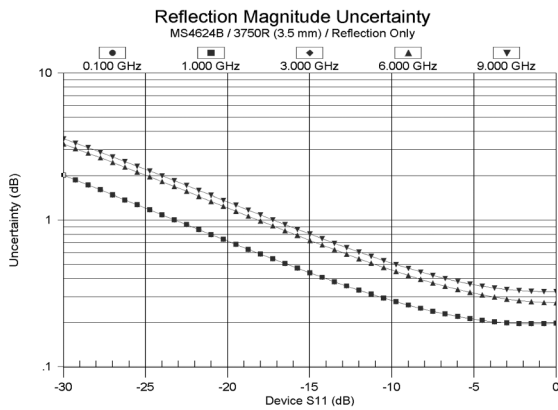

Reflection Measurements: 3.5 mm Connectors

Configuration Overview

Scorpion is available in many powerful configurations to satisfy all of your RF measurement requirements; furthermore, Scorpion is easy to upgrade as your measurement requirements expand. Configuring your Scorpion is as easy as following this three-step process:

- (1) Choose the desired S-parameter measurement configuration
- (2) If required, specify the 2nd Source part number according to this selected configuration
- (3) If required, add additional options and specify connector type

The latest manufacturing techniques enable you to preserve your investment. With the modular and compartmentalized infrastructure, Scorpion is easy to manufacture, maintain, and upgrade.



(1) Choose the desired S-parameter measurement configura-

	10 MHz - 3 GHz	10 MHz - 6 GHz	10 MHz - 9 GHz
2-Port T/R ¹	MS4622A	MS4623A	MS4624A
2-Port	MS4622B	MS4623B	MS4624B
3-Port	MS4622B + MS4600/3A	MS4623B + MS4600/3B	MS4624B + MS4600/3E
3-Port T/R ²	MS4622B + MS4600/6	MS4623B + MS4600/6	MS4624B + MS4600/6
4-Port	MS4622D	MS4623D	MS4624D
2-Port DRA ³	MS4622C	MS4623C	MS4624C
3-Port DRA ³	MS4622C + MS4600/3C	MS4623C + MS4600/3D	MS4624C + MS4600/3F

¹T/R is economical Transmission/Reflection (or one-path, two-port) configuration that measures S₁₁, S₂₁

²3-Port T/R measures 2-port S-parameters plus two-path, three-port measurements.

³DRA is Direct Receiver Access configuration for use in developing custom solutions.

2) For IMD and/or Mixer configurations, make sure to include the second source part number

Option MS4600/3x, as shown in the following table, adds an additional integrated source to support S-parameter measurements of 3-port devices. This integrated source also supports mixer measurements and intermodulation distortion (MS4600/13 provides integrated application software to simplify IMD testing) measurements.

Option Description	Part Number
3 GHz Second Source for MS4622B	MS4600/3A
6 GHz Second Source for MS4623B	MS4600/3B
9 GHz Second Source for MS4624B	MS4600/3E
3 GHz Second Source for MS4622C	MS4600/3C
6 GHz Second Source for MS4623C	MS4600/3D
9 GHz Second Source for MS4624C	MS4600/3F

This additional source (Option 3x) is standard in the 4-port network analyzer (i.e. "D" Models) and supports true S-Parameter measurements of 4-port devices.

(3) Finally, specify any additional options to complete your configuration

Scorpion can be further upgraded to include the following options:

Option Description	Part Number	Availability
Time Domain	MS4600/2	All Models
3 GHz Noise Figure ¹	MS4600/4, 4D, 4F	B, C and D Models respectively
6 GHz Noise Figure ¹	MS4600/4B, 4E, 4G	B, C and D Models respectively
Frequency Translating Group Delay (FTGD)	MS4600/5	B and D Models Only
T/R Step Attenuator	MS4600/7	A Models Only
Harmonic Measurement	MS4600/8	All Models
Test Port Connector ²	MS4600/11	All Models
Intermodulation Distortion ³	MS4600/13	All Models
500 MB Internal Hard Drive	MS4600/15	All Models

¹Noise Figure measurements start at 50 MHz

²Standard Connector is N-female, also available is N male (MS4600/11NM), 3.5mm male (MS4600/11S), 3.5mm female (MS4600/11SF), and GPC-7 male (MS4600/A)

³Intermodulation Distortion requires an additional source (external source or reference MS4600/3x)

MODELS

A flexible choice of models from “economical” to “fully-loaded, deadly accurate” ensures you can configure a system to satisfy your requirements. You can upgrade the model between frequency ranges and configurations as your requirements change for additional value.

Configuration Summary	MS462x 10 MHz to 3 GHz	MS4623x 10 MHz to 6 GHz	MS4624x 10 MHz to 9 GHz
MS462xA T/R ¹	✓	✓	✓
MS462xB S-Parameter	✓	✓	✓
MS462xC DRA ²	✓	✓	✓
MS462xD 4-Port	✓	✓	✓

¹T/R is economical Transmission/Reflection (or one-path, two-port) configuration that measures S₁₁, S₂₁.

²DRA is Direct Receiver Access configuration for use in developing custom solutions.

MS462xA Transmission/Reflection Analyzer

These economical analyzers are one path, two port network analyzers that satisfies high volume passive RF production requirements for stability, reliability, speed, dynamic range and accuracy.

MS4622A: 10 MHz to 3 GHz, 2-Port, T/R

MS4623A: 10 MHz to 6 GHz, 2-Port, T/R

MS4624A: 10 MHz to 9 GHz, 2-Port, T/R

MS462xB Vector Network Measurement System (VNMS)

For passive, active, and frequency translating devices, these powerful S-parameter configurations offer the performance, ease-of-use and versatility of a vector network analyzer (VNA) with an amazing twist: integrated options that allow 3-Port, Noise Figure, Harmonic, Frequency Translating Group Delay and Intermodulation Distortion (IMD) measurements. The 3-port configuration includes mixed-mode S-parameters, arbitrary impedance and powerful embedding/de-embedding routines, too.

MS4622B: 10 MHz to 3 GHz, 2-Port

MS4623B: 10 MHz to 6 GHz, 2-Port

MS4624B: 10 MHz to 9 GHz, 2-Port

MS462xC VNMS / Direct Receiver Access

With direct access to the receivers (i.e. without an integrated test set), these vector network analyzers offer the ultimate flexibility for power amplifiers, frequency translating, and multiple output device requirements.

MS4622C: 10 MHz to 3 GHz, 2-Port

MS4623C: 10 MHz to 6 GHz, 2-Port

MS4624C: 10 MHz to 9 GHz, 2-Port

MS462xD VNMS / 4-Port, Balanced Differential Measurements

This newest 4-port measurement solution includes mixed-mode S-Parameters, arbitrary impedance, powerful embedding/de-embedding routines and the second internal source to tame your toughest RF device requirements. Many of these new features are available in the existing model configurations, too.

MS4622D: 10 MHz to 3 GHz, 4-Port

MS4623D: 10 MHz to 6 GHz, 4-Port

MS4624D: 10 MHz to 9 GHz, 4-Port

Options

Rack Mount

MS4600/1: Rack Mount Kit with Slides

For all models, rack mount kit containing a set of track slides (90° tilt capability), mounting ears, and front panel handles for mounting the instrument in a standard 19-inch equipment rack.

MS4600/1A: Rack Mount Kit with Handles

For all models, rack mount kit containing a set of mounting ears and hardware to permanently mount instrument in a standard 19-inch equipment rack. Slides are not provided.

Time Domain

MS4600/2: Time (Distance) Domain

For all models, Time domain analysis can also be performed utilizing Lowpass, Bandpass or Phasor Impulse processing techniques. Windows and Gating support additional conditioning to further enhance time domain processing.

Second Internal Source, Third Test Port

The following options add internal second source, third test port and test attenuator. The appropriate models are also shown.

MS4600/3A: MS4622B, 3 GHz

MS4600/3B: MS4623B, 6 GHz

MS4600/3C: MS4622C, 3 GHz

MS4600/3D: MS4623C, 6 GHz

MS4600/3E: MS4624B, 9 GHz

MS4600/3F: MS4624C, 9 GHz

Noise Figure

The following options add integrated Noise Figure measurements. Noise Source not included. The appropriate models are also shown.

NF Options, 50 to 3000 MHz

MS4600/4: MS4622B, MS4623B, MS4624B

MS4600/4D: MS4622C, MS4623C, MS4624D

MS4600/4F: MS4622D, MS4623D, MS4624D

NF Options, 50 to 6000 MHz

MS4600/4B: MS4623B, MS4623B

MS4600/4E: MS4623C, MS4624C

MS4600/4G: MS4623D, MS4624D

Noise Sources

NC346A: 3.5mm, 5 dB ENR Noise Source

NC346B: 3.5mm, 15 dB ENR Noise Source

Frequency Translating Group Delay

MS4600/5: Frequency Translating Group Delay

For MS462xB and MS462xD, adds mixer group delay measurement.

Third Test Port Without Second Internal Source

MS4600/6: Third Test Port

For MS462xB and MS462xC, adds third test port on front panel with routing to rear panel for external source (3.5mm rear panel connector). Configuration supports 12-term (2-port) vector correction plus vector correction of S₁₁, S₂₁ and S₃₁ on 3-port devices. With external source, 3-port (24-term) calibrations can be performed.

Source Step Attenuator

MS4600/7: T/R Step Attenuator

For MS462xA, adds internal step attenuator to internal source.

Harmonic Measurements

MS4600/8: Harmonic Measurements

For all models, adds firmware to orchestrate harmonics measurements.

Connector Designation

Standard front panel connector type is N female. Use the following options to specify optional connector types. Connector type is the same for all ports.

- MS4600/11NM:** Replaces N female with N male Test Port Adapters
- MS4600/11S:** Replaces N female with 3.5mm male Test Port Adapters
- MS4600/11SF:** Replaces N female with 3.5mm female Test Port Adapters
- MS4600/11A:** Replaces N female with GPC-7 male Test Port Adapters

Intermodulation Distortion Measurements

MS4600/13: Intermodulation Distortion Measurements
For all models, adds firmware to orchestrate CW, swept frequency and swept power IMD measurements. Second source is required (reference MS4600/3x) or external source can be used.

Memory

MS4600/15: Internal 500 MB Hard Drive

Calibration Options

- MS4600/98:** Z540/Guide 25 Calibration
- MS4600/99:** Premium Calibration
- 3670NN50-1:** N(m)-N(m) Cable, 30.5 cm (1 ft.)
- 3670NN50-2:** N(m)-N(m) Cable, 61 cm (2 ft.)

GPIB Cables

- 2100-5:** GPIB Cable, 0.5 m (1.6 ft.)
- 2100-1:** GPIB Cable, 1 m (3.3 ft.)
- 2100-2:** GPIB Cable, 2 m (6.6 ft.)
- 2100-4:** GPIB Cable, 4 m (13.2 ft.)

Calibration Kits

Using Anritsu's precision coaxial OSLT calibration kits ensures accurate operation of your MS462xx series VNMS. These kits include precision components required to perform the requisite calibrations.

Standard (10 MHz to 9 GHz)

- 3750R:** SMA/3.5 mm Calibration Kit
- 3750R/1:** Adds a set of five Phase Equal Insertables (PEIs).
- 3750R/3:** Adds additional 3.5 mm (female) and 3.5 mm (male) terminations required for four port calibrations.
- 3751R:** GPC-7 Calibration Kit
- 3751R/2:** Adds a third GPC-7 termination required for three port calibrations.
- 3751R/3:** Adds two additional GPC-7 terminations required for four port calibrations.
- 3753R:** N (50Ω) Connector Calibration Kit
- 3753R/1:** Adds a set of five Phase Equal Insertables (PEIs).
- 3753R/3:** Adds additional N (female) and N (male) terminations required for four port calibrations.
- 3753-75R:** N (75Ω) Calibration Kit, Specified to 3 GHz
- 3753-75R/3:** Adds additional N (75 Ohm female) and N (75Ω male) terminations required for four port calibrations.

Verification Kits

Anritsu offers a complete line of coaxial verification kits to confirm your system's performance. All verification kits contain precision components with characteristics traceable to the US National Institute of Standards and Technology (NIST).

- 3663R:** Type N Verification Kit
- 3666R:** SMA/3.5 mm Verification Kit
- 3667R:** GPC-7 Verification Kit

AutoCal®

The AutoCal modules are automatic precision calibrators that provide fast, repeatable, and accurate coaxial calibrations up to 9 GHz. The AutoCal system includes the module, serial cable, power supply, power cord, characterization disk, and operational manual. Scorpion has standard firmware to control AutoCal so no further options are required for auto-calibrations.

- 36581NNF/2:** N(m) to N(f), 10 MHz to 9 GHz
- 36581KKF/2:** K(m) to K(f), 10 MHz to 9 GHz
- 36584KF:** 4-Port K(f), 10 MHz to 9 GHz
- 36584NF:** 4-Port N(f), 10 MHz to 9 GHz
- 36583S:** Test Port Cable Converter Set, SMA type
- 36583L:** Test Port Cable Converter Set, 3.5mm type
- 36583K:** Test Port Cable Converter Set, K type
- 760-208:** Transit Case for AutoCal

Test Port Cables

High Performance, Flexible

- 15LL50-0.3A:** 3.5 mm Cable, Male to Male, 30 cm (11.8 in.)
- 15LL50-0.6A:** 3.5 mm Cable, Male to Male, 60 cm (23.6 in.)
- 15LLF50-0.3A:** 3.5 mm Cable, Male to Female, 30 cm (11.8 in.)
- 15LLF50-0.6A:** 3.5 mm Cable, Male to Female, 60 cm (23.6 in.)
- 15NN50-0.3A:** Type N Cable, Male to Male, 30 cm (11.8 in.)
- 15NN50-0.6A:** Type N Cable, Male to Male, 60 cm (23.6 in.)
- 15NNF50-0.3A:** Type N Cable, Male to Female, 30 cm (11.8 in.)
- 15NNF50-0.6A:** Type N Cable, Male to Female, 60 cm (23.6 in.)

Economy, Armored Semi-Rigid

- 3670A50-1:** GPC-7 Cable, 30.5 cm (1 ft.)
- 3670A50-2:** GPC-7 Cable, 61 cm (2 ft.)
- 3670K50-1:** K(f)-K(m) Cable, 30.5 cm (1 ft.)
- 3670K50-2:** K(f)-K(m) Cable, 61 cm (2 ft.)
- 3670KF50-1:** K(f)-K(f) Cable, 30.5 cm (1 ft.)
- 3670KF50-2:** K(f)-K(f) Cable, 61 cm (2 ft.)
- 3670N50-1:** N(f)-N(m) Cable, 30.5 cm (1 ft.)
- 3670N50-2:** N(f)-N(m) Cable, 61 cm (2 ft.)

Precision Adapters

Coaxial

- 34NK50:** Adapter, DC to 18 GHz, 50Ω, N(m)-K(m)
- 34NKF50:** Adapter, DC to 18 GHz, 50Ω, N(m)-K(f)
- 34NFK50:** Adapter, DC to 18 GHz, 50Ω, N(f)-K(m)
- 34NFKF50:** Adapter, DC to 18 GHz, 50Ω, N(f)-K(f)

Fixed Attenuators

- 43KB-3:** Fixed Attenuator, 3 dB, DC to 26.5 GHz, 50Ω, K(m) to K(f)
- 43KB-6:** Fixed Attenuator, 6 dB, DC to 26.5 GHz, 50Ω, K(m) to K(f)
- 43KB-10:** Fixed Attenuator, 10 dB, DC to 26.5 GHz, 50Ω, K(m) to K(f)
- 43KB-20:** Fixed Attenuator, 20 dB, DC to 26.5 GHz, 50Ω, K(m) to K(f)

75Ω Accessories

- 34NN75B:** Precision Adapter, DC to 3 GHz, 75Ω, N(m)-N(m)
- 34NFN75B:** Precision Adapter, DC to 3 GHz, 75Ω, N(f)-N(f)
- 1091-137:** Adapter, DC to 1500 MHz, 75Ω, N(f)-F(m)
- 1091-168:** Adapter, DC to 1500 MHz, 75Ω, N(m)-F(m)
- 1091-169:** Adapter, DC to 1500 MHz, 75Ω, N(m) F(f)
- 1091-170:** Adapter, DC to 1500 MHz, 75Ω, N(f)-F(f)
- 11N75B:** Power Divider, 1 MHz to 3 GHz, 75Ω, N(f) input, N(f) output

Software

2300-218:	Anritsu Power Tools, Windows® Instrument Drivers
2300-232:	Mixer Measurement Assistant (NxN)
2300-361:	Exact Uncertainty
2300-364:	Scorpion Command Encyclopedia

Printer

2000-1214:	HP Desk Jet Printer, Model 450
2000-1216:	Black Printer Cartridge, Model 450
2000-1217:	Rechargeable Battery, Model 450
2000-1218:	Desk Jet Power Cord (UK)
2000-663:	Desk Jet Power Cord (Europe)
2000-664:	Desk Jet Power Cord (Australia)
2000-666:	Desk Jet Power Cord (Japan)
2000-667:	Desk Jet Power Cord (South Africa)
2225-6:	Parallel Interface Printer Cable

Other Accessories and Tools

01-201:	5/16" Torque Wrench, 8 ft-lbs, for SMA, 3.5 mm, and K Connectors
01-204:	Anritsu Stainless Steel Connector Wrench
760-216:	Scorpion (MS462xx) Transit Case
2000-1065:	0.9 m SCSI Cable (SCSI-2 - DB25 Male)
2000-1066:	104 Key AT Connector Keyboard
2000-1208:	Ethernet Transceiver
2000-1209:	Crossover Ethernet Cable

MS4600A/B/C/D External Hard Drive**

(includes PCMCIA Drive with Power Supply, SCSI Interface Cable, and 128 Mb Flash PCMCIA Memory Card)

2000-1406:	Scorpion External Hard Drive (for use in the United States)
2000-1407:	Scorpion External Hard Drive (for use in Europe, except United Kingdom)
2000-1408:	Scorpion External Hard Drive (for use in United Kingdom)
2000-1409:	Scorpion External Hard Drive (for use in Australia)

Extended Service Options

Standard Warranty is for 3 years, which covers the Scorpion mainframe, options, noise sources, and harmonic phase standard.

On-Site Support Plans

Option ES31:	3 Year On-Site Repair
Option ES37:	3 Year On-Site Standard Calibration
Option ES38:	3 Year On-Site Premium Calibration

Return-to-Service Center Support Plans

Option ES32:	3 Year Return-to-Service Center Standard Calibration
Option ES34:	3 Year Return-to-Service Center Premium Calibration
Option ES50:	5 Year Return-to-Service Center Repair Only
Option ES52:	5 Year Return-to-Service Center Standard Calibration
Option ES54:	5 Year Return-to-Service Center Premium Calibration
Option ES55:	5 Year Return-to-Service Center Repair plus Standard Calibration
Option ES56:	5 Year Return-to-Service Center Repair plus Premium Calibration

Upgrade Options*

MS4622x to MS4623x or MS4624x*

MS4623x to MS4624x*

Add Additional Options*

*Please contact your Anritsu representative for pricing and delivery.

**Not operational with Option 15, 500 MB internal drive.

Related Literature

Brochures

Scorpion Family Brochure	11410-00289
Scorpion Technical Specifications	11410-00288
PATS Brochure	11410-00263
TMATS Brochure	11410-00292
2-Port AutoCal Brochure	11410-00189
4-Port AutoCal Brochure	11410-00294
PIM-S	11410-00349
RF Multi-Port Balanced VNA	11410-00352
Microwave Multiport Balanced VNA	11410-00335

Application Notes

CDROM, Scorpion Literature	10920-00040
2-Port AutoCal Automatic Calibrator	11410-00258
4-Port AutoCal Automatic Calibrator	11410-00298
Noise Figure	11410-00210
Noise Figure Accuracy	11410-00227
Noise Figure Corrections	11410-00256
Intermodulation Distortion	11410-00213
Harmonics	11410-00222
Frequency Translated Group Delay	11410-00236
Global Power Sweep	11410-00243
Multiple Source Control	11410-00244
Reflectometer Measurements-Revisited	11410-00214
Time Domain	11410-00206
Adjacent Channel Power Ratio (ACPR)	11410-00264
What is Your Measurement Accuracy?	11410-00270
Embedding/De-embedding	11410-00278
Three and Four Port S-parameter Measurements	11410-00279
Arbitrary Impedance	11410-00284
Hot S22 and Hot K-factor Measurements	11410-00295
Pulse S-parameters Measurements	11410-00300
Faster Measurements Using Flexible Cal	11410-00310
RF Design Nov 1999	11410-00240
Extended Receiver Calibrations in MS462xx VNAs	11310-00351
12 Reasons to Leave Your Old VNA for Scorpion	11410-00374
Agilent 8753 to Anritsu Program Conversion Guide	11410-00371
Measurements of Non-Insertable Devices	11410-00382

Manuals

MS462XX Operation Manual	10410-00203
MS462XX Programming Manual	10410-00204
MS462XX Maintenance Manual	10410-00205
MS462XX GPIB Quick Reference Guide	10410-00206
Measurement Guide	10410-00213
Application Guide	10410-00214
PATS Operation Manual	10410-00225
TMATS Operation Manual	10410-00244
MN4790A Maintenance Manual	10410-00245
ME7840/4 Operation Manual	10410-00247
MN4783A Maintenance Manual	10410-00248
Scorpion Navigator Software User's Guide	10410-00249

Software Utilities and Drivers

Scorpion Command Encyclopedia	2300-364
Power Tools	2300-218
Exact Uncertainty	2300-361
Mixer Measurements Assistant (NxN)	2300-232



ANRITSU Corporation

5-1-1 Onna, Atsugi-shi, Kanagawa, 243-8555 Japan
Phone: +81-46-223-1111
Fax: +81-46-296-1264

- Australia

ANRITSU Pty Ltd.

Unit 3/170 Forster Road Mt. Waverley,
Victoria, 3149, Australia
Phone: +61-3-9558-8177
Fax: +61-3-9558-8255

- Brazil

ANRITSU Eletrônica Ltda.

Praca Amadeu Amaral, 27-1 andar
01327-010 - Paraiso, Sao Paulo, Brazil
Phone: +55-11-3283-2511
Fax: +55-11-3886940

- Canada

ANRITSU Electronics Ltd.

700 Silver Seven Road, Suite 120, Kanata,
ON K2V 1C3, Canada
Phone: +1-613-591-2003
Fax: +1-613-591-1006

- Denmark

ANRITSU A/S

Kirkebjerg All 90 DK-2605 Brøndby, Denmark
Phone: +45-72112200
Fax: +45-72112210

- Finland

ANRITSU AB

Teknobulevardi 3-5, FI-01530 Vantaa, Finland
Phone: +358-9-4355-220
Fax: +358-9-4355-2250

- France

ANRITSU S.A.

9, Avenue du Québec Z.A. de Courtaboeuf
91951 Les Ulis Cedex, France
Phone: +33-1-60-92-15-50
Fax: +33-1-64-46-10-65

- Germany

ANRITSU GmbH

Nemetschek Haus Konrad-Zuse-Platz 1 81829
München, Germany
Phone: +49 (0) 89 442308-0
Fax: +49 (0) 89 442308-55

- Hong Kong

ANRITSU Company Ltd.

Suite 923, 9/F., Chinachem Golden Plaza, 77 Mody
Road, Tsimshatsui East, Kowloon, Hong Kong, China
Phone: +852-2301-4980
Fax: +852-2301-3545

- India

ANRITSU Corporation, India Liaison Office

Unit No.S-3, Second Floor, Esteem Red Cross Bhavan,
No.26, Race Course Road, Bangalore 560 001 India
Phone: +91-80-30944707

- Italy

ANRITSU S.p.A.

Via Elio Vittorini, 129, 00144 Roma EUR, Italy
Phone: +39-06-509-9711
Fax: +39-06-502-2425

- Korea

ANRITSU Corporation, Ltd.

8F Hyun Juk Bldg. 832-41, Yeoksam-dong,
Kangnam-ku, Seoul, 135-080, Korea
Phone: +82-2-553-6603
Fax: +82-2-553-6604

- P. R. China

ANRITSU Company Ltd.

Beijing Representative Office
Room 1515, Beijing Fortune Building, No. 5 North Road,
the East 3rd Ring Road, Chao-Yang District
Beijing 100004, P.R. China
Phone: +86-10-6590-9230

- Singapore

ANRITSU Pte Ltd.

10, Hoe Chiang Road #07-01/02, Keppel Towers,
Singapore 089315
Phone: +65-6282-2400
Fax: +65-6282-2533

- Sweden

ANRITSU AB

Borgarfjordsgatan 13 164 40 Kista, Sweden
Phone: +46-853470700
Fax: +46-853470730

- Taiwan

ANRITSU Company Inc.

7F, No. 316, Sec. 1, NeiHu Rd., Taipei, Taiwan
Phone: +886-2-8751-1816
Fax: +886-2-8751-1817

- U.K.

ANRITSU EMEA Ltd.

200 Capability Green, Luton, Bedfordshire LU1 3LU, U.K.
Phone: +44-1582-433280
Fax: +44-1582-731303

- U.S.A.

ANRITSU Company

1155 East Collins Boulevard,
Richardson, Texas 75081
Toll Free: 1-800-ANRITSU (267-4878)
Phone: +1-972-644-1777
Fax: +1-972-644-3416

